

APPROVED IN ACCORDANCE WITH THE EUROPEAN STANDARD 2014/34/EU - ATEX

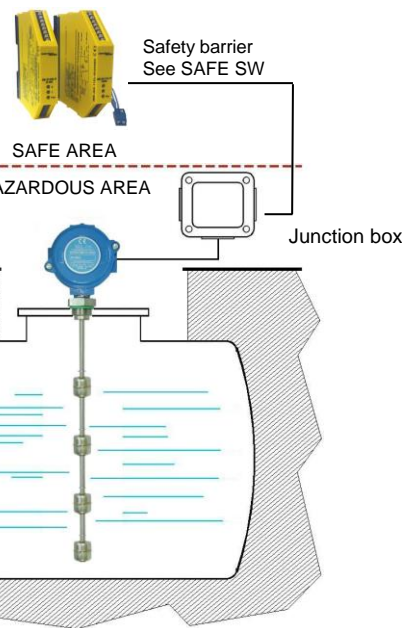

These instruments, intrinsically safe certified:

CESI 03 ATEX 265 Ext.2 II 1G Exia IIC T4/T5/T6 Ga,
CESI 03 ATEX 265 Ext.2 II 1/2G Exia IIC T4/T5/T6 Ga/Gb,
 are used to control the level of liquids or fuel in tanks, both underground and outdoors, installed in hazardous areas where flammable products are treated.

GENERAL CHARACTERISTICS

- **Stainless steel – AISI 316**
- Up to 6 switch points.
- Up to 6 m length.
- Maximum working pressure 50 bar depending on used float.
- Standard working temperature up to 100°C.
- Executions up to 160°C on request.
- Operating ambient temperature
 -40/+40°C = T6, -40/+55°C = T5, -40/+80°C = T4
- Minimum degree of protection IP65.

FLOATS

Tab.1



Material	Stainless steel – AISI 316									
Specific gravity	0,75		0,55		0,65		0,7		0,6	
Contact type	3	7D	3	7D	4	7	4	7	7	
Max N. of contacts	6	4	6	4	6		6		6	
Max. bar	30		10		10		50		15	
Max. °C - Class	L = 100°C									
On request	N = 130°C / R = 160°C									

ELECTRICAL CONTACTS

Tab.2

TYPE	POWER				VOLTAGE		CURRENT	
	VA	W	AC	DC	AC	DC		
SPST	3	70	50	300	350	0,5	0,7	
SPST	4	80	80	250	250	1,3	1,3	
SPDT	7	60	60	230	230	1	1	
SPDT	7D	20	20	150	150	0,5	0,5	

ELECTRICAL OUTPUT

Tab.3

I1	I2	I3	IS1	IC1 - IC2	IP1 - IP2
IP65 housing (2G)	IP65 housing (2G)	IP66/67 housing (1G)	DIN43650 plug IP65 (1G)	Cable IP65 (1G)	Cable-gland (1G)
5 terminals	18 terminals	18 terminals	DIN43650 29x29	IC1 Cable L = 1,5m IC2 Cable L = 3,0m	IP1 Brass IP68 IP2 Polyamide IP67

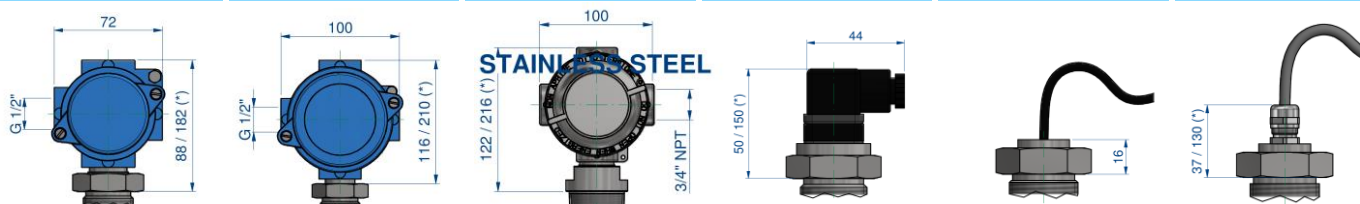

With heatsink - see dimension (*) Temperature class **N - R = T6 - T5** Temperature class **N = T4** heatsink not needed

PROCESS CONNECTIONS

Tab.4

Installation from inside IC– IP output				Float type	Installation from outside – available thread and flanges						
06 1/8"	08 1/4"	10 3/8"	15 1/2"		25 1"	32 1 1/4"	40 1 1/2"	50 2"	FSHX Flange	FSPX Flange	DN Flange
All type of floats All type of thread				S29	G	G-C-N	-	-	•	•	•
				S32	G	G-C-N	-	-	•	•	•
				S41	-	-	G-C-N	G-C-N	-	-	•
				S52	-	-	-	G-C-N	-	-	•
				S100	-	-	-	-	-	-	•

Male thread

G	C	N
Parallel UNI 228/1	Conical UNI 7/1	Conical NPT

Available materials

S	T
AISI-316	AISI-304 On request

DN - Available materials

C	S
Steel	AISI-316

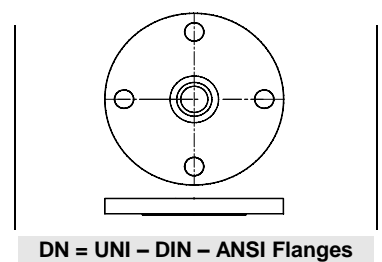
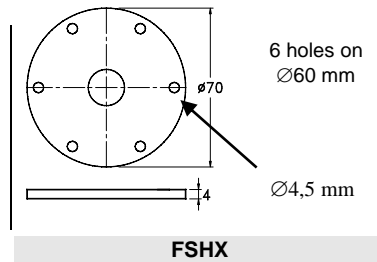
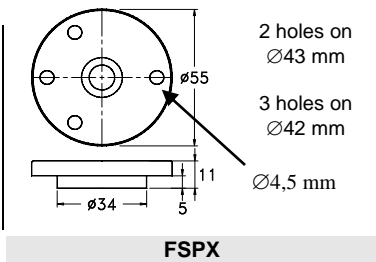

SAFETY BARRIERS

All Exia level controls must be electrically connected to the active or passive barriers according to the European Standard EN 50020. See technical bulletin SAFE SW.

A Flanged connection
A1 Threaded connection

WIRING

Tab.5

I	Independent	Separately wired contacts	1	NO	Contacts status in no level conditions
C	Common	Common wired contacts	2	NC	
S	Custom	Contacts wired on request	3	SPDT (*)	

(*) Connected to barrier input just as NO or NC

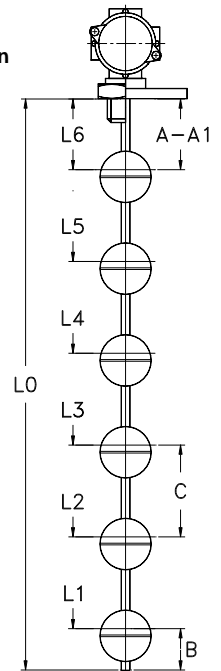

SWITCH POINTS - minimum value in mm.

Tab.6

The switch points L1 ÷ L6 are measured from the stop of the fitting or flange connection. General tolerances on switch points ± 3 mm.

	Minimum distance in mm.									
	S29		S32		S41		S52		S100	
A	20		20		30		35		60	
A1	40		40		50		55		-	
B	25		25		35		40		70	
C	45		45		65		75		125	
Contact type	3	7D	3	7D	4	7	4	7	7	
Max. N. contacts	6	4	6	4	6	6	6	6	6	

NOMENCLATURE

M2	S52	4	1300	S	50	G	S	I1	L	I22	L1÷L6	
•												Number of contacts S1 / M2÷M6
	•											Tab.1 Float
		•										Tab.2 Electrical contact
			•									- Total length = L0 in mm. (See drawing)
				•								- Rod material
					•							Tab.4 Process connection dimension
						•						Tab.4 Process connection thread
							•					Tab.4 Process connection material
								•				Tab.3 Electrical output
									•			Tab.1 Temperature class
										•		Tab.5 Wiring and contact status
											•	Tab.6 Switch points (mm)

MULTIPOINT S - ATEX I

Request form

External mounting

Internal mounting

I1 I2

Electrical housing IP 65
W1 max. 5 terminals 70mm
W2 max. 18 terminals 100mm

I3

Electrical housing IP 66/67
Stainless steel - AISI 316
Max. 18 terminals

IS1 IS2

Plug DIN 43650
29x29 or 15x15
Max 3 terminals

IP1 IP2

P1 Cable-gland IP68
P2 Cable-gland IP67
L cable.....mm

IC

Cable L.....mm

IC

Only internal mounting
Cable L.....mm

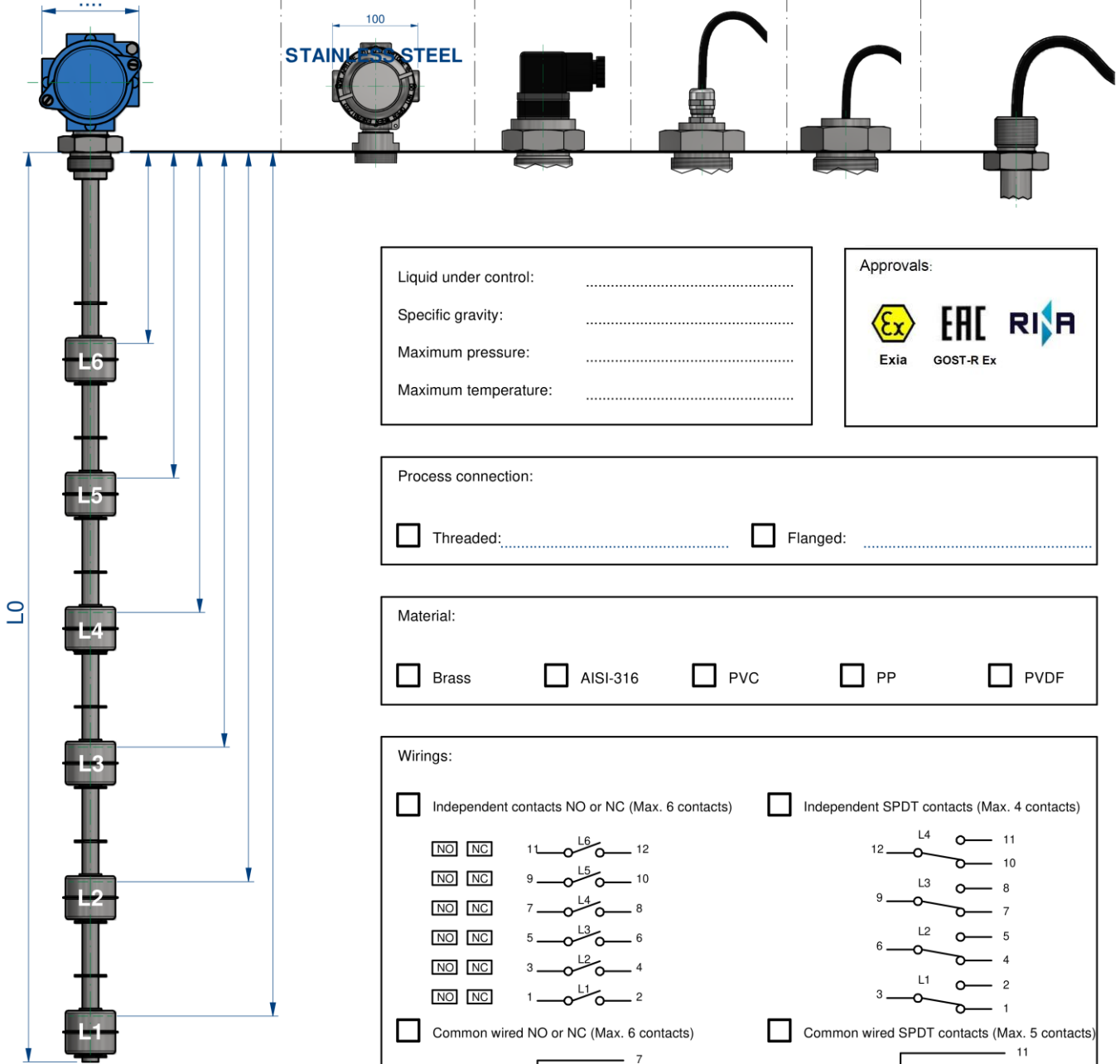

Total length L0 (mm)

Liquid under control:

Specific gravity:

Maximum pressure:

Maximum temperature:

Approvals:

Exia GOST-R Ex

Process connection:

Threaded: Flanged:

Material:

Brass AISI-316 PVC PP PVDF

Wirings:

Independent contacts NO or NC (Max. 6 contacts)

Independent SPDT contacts (Max. 4 contacts)

Common wired NO or NC (Max. 6 contacts)

Common wired SPDT contacts (Max. 5 contacts)